

Snipe Class International Racing Association



2020 Official Snipe Measurer Handbook





SCIRA

Snipe Class International Racing Association

2812 Canon Street - San Diego, CA 92106 USA

jerelyn@odmsail.com

snipe.org

Covers photos credits: Matias Capizzano

This Handbook is updated to April 2020

Introduction

SCIRA has been in existence for 85 years with about 32,000 boats built around the world. Shortly after the proliferation of the Class, a need for measurement to ensure consistency and to maintain the one-design nature was necessary.

Original boats were made of wood and the current tolerances exist to accommodate those who still prefer to build Snipes of plywood. Once fiberglass Snipes were introduced, the measurement process became more standard with molds. However, modernization and the evolution of the Snipe over its 85 years have necessitated standardization of the measurement process.

This handbook is to assist each country to ensure proper measurement techniques and apply consistency of measurement around the world for Snipes.

Remember that Snipe measurements shall be conducted according to this handbook, the Snipe Class Rules, the World Sailing Equipment Rules of Sailing and the World Sailing International Measurers Manual, other than the Racing Rules of Sailing where applicable.

From the Rules Committee Chairman

The purpose of the SCIRA Measurement Handbook and the intent of the Rules Committee are to standardize Snipe measurement worldwide. A clear explanation of the preferred method will ensure as much as possible that all measurers will follow and apply the rules in all countries in the same way.

To reach this goal, SCIRA International selected, produced and distributed a set of approved tools to all National Secretaries and builders. An updated, standard measurement frame was also created to more concisely measure the Snipe. More tools are now being studied to make measurement easier.

Springs for the MOI test are distributed exclusively by the SCIRA Office accompanied by the constant figures necessary to determine the minimum time to reach the 271 kg*sq.m which is now the correct value after the adoption of the I.S. as standard.

The combined use of the above mentioned tools allow measurers to inspect the boats in a standard, fair and efficient way.

Also introduced, and now enforced after the approval of the new Class Rules written according to the World Sailing standard approved for the recognised International Classes, were the measurement stickers that at completion of measurement are applied on measured equipment. This system saves time and control at all events for both the measurers and sailors alike.

SCIRA also continue to hold measurement clinics at World Championships to educate current and new measurers on the latest measurement process.

The intent of Rules Committee with the support of Board of Governors is to continue to have coordinated Snipe measurement worldwide.

Antonio Bari
Rules Committee Chairman 2017-2020

Acknowledgements

Thanks to all those who tirelessly helped put this handbook together;

Text: Antonio Bari, Giorgio Brezich, Steve Stewart, Jerelyn Biehl

Photography: Phillip Magura, Antonio Bari, Giorgio Brezich, Aoi Funaki

Drawings: Antonio Bari, Matt Anderson



Measurer Requirements & Responsibilities

The basis of the measurement process begins with the National Secretary organizing the various levels of measurers.

The National Secretary

- Keeps list of current measurers in the country;
- Assigns SCIRA stamps to appropriate measurers sending corresponding list to SCIRA Chief Measurer with copy to SCIRA Office;
- Issues Measurement Certificates to owners based upon recommendation from the National or International Measurer;
- Appoints, after appropriate training period, the Measurers according to the following requirements:

Fleet: is the measurer of the fleet elected by fleet members (see Constitution, section 9) entitled to measure sails, spars, weight, verify decals and stickers and generally overview the boats compliance to rules. The fleet measurer should re-weigh the fleet boats at start of each season.

Responsibilities

- Hold annual weighing session and possible measurement update for fleet members
- Notify the National Secretary any changes in the Measurement Certificate
- Attend measurement clinic when possible

National: is a more experienced measurer, appointed by the National Secretary after a training period as fleet measurer and after participating in a national measurer's clinic called by the National Secretary, or to an international clinic. He is entitled to measure the boats at events of a national level, and cooperate with international measurers at international events. National measurers are entitled to fully measure and check boats and equipment and use the SCIRA stickers to permanently identify the hull and other items already checked and found conform to rules. A National Measurer is entitled to become a Certified Builder measurer.

Responsibilities

- Organize measurement clinics for national measurers
- Oversee measurement at National championship and at major championships held in your country
- Report measurement inconsistencies to Chief Measurer
- Propose recommendations for measurement rules to Chief Measurer or Rules Committee
- Attend international measurement clinic

International: is one of restricted and most experienced measurers, identified by the International Chief Measurer and appointed by the Rules Committee, that have participated in an International Measurer's clinic. An International Measurer is entitled to assist the professional builders, measure their plugs, moulds and the production as per Builders Certification, *section 3*. He is also entitled to appoint National Measurers to serve as builders' measurers as per Builders Certification, *section 5*. The international measurers will report their comments on rules application to the Chief Measurer.



International Rules Committee

The Board of Governors shall appoint a Technical Committee consisting of the Chairman of the International Rules Committee, Vice Chairman, Chief Measurer, Rules Committee members and the Chief Information Officer. The Rules Committee in accordance with World Sailing Regulations shall maintain, study and make recommendations on all Class measurement rules and restrictions. This Committee, in accordance with World Sailing Regulations, shall have power to record or clarify any measurement rule or restriction whenever its meaning is deemed not clear or unfair. Proposed changes shall be submitted by March 1 and circulated to all members of the International Rules Committee for comments and recommendations as well as publication of the proposal via the Snipe Bulletin, posting on the website and via email to all National Secretaries with discussion held from March to June. The Rules Committee will then discuss, vote and make recommendations to the Board for consideration of a vote by the Board of Governors July 1-10. Measurement rules changes may take effect only on January 1 of each leap year (2000, 2004, 2008, etc.) and then only if submitted to the Board as agenda items by March 1 of the preceding year. Each proposed measurement rules change must appear on at least two agendas, with amendments offer able on the first circulation, and a vote on the amendments on the second or final vote on the change if no amendments were offered. Consideration at a properly called meeting of the Board may count as the second or third agenda appearance. Changes can be made at times other than the specified four-year intervals where the Board considers them to be of extreme urgency. An absolute majority of the Board is required for final passage. If approved, the proposed rule will be submitted to WS for approval and if approved, will be published to the members by December 1 with application January 1.

Whenever a "circular Letter" from the International Rules Committee over the signature of the Chairman appears in the *Snipe Bulletin* or is posted on the Snipe web page the corrections, interpretations or simplifications appearing therein shall become a part of the current Official Rulebook. Such corrections, interpretations or simplifications will also be posted on the Snipe web site, Rules section.

Chief Measurer

The Board of Governors shall appoint a Chief Measurer. He shall serve a four years term with re-election possible after the first term. He shall be responsible for managing the Class Measurers worldwide. He shall be a member of the Rules Committee and shall advise that Committee on Measuring Rules problems. The Chief Measurer shall supervise all certified measurers, grant or reject measurement certificates, issue duplicates, and answer questions on measurement rules in coordination with the Chairman of the Rules Committee. Subject to the approval of the Technical Committee, he shall establish and maintain measurement standards, forms and techniques. He shall maintain liaison with the Technical Committee, and may recommend to the Board changes in plans and specifications.

International Rules Committee Members 2017 - 2020

| | | | |
|----------------------------------|---------------------------------|-----------|------------------------------------|
| Chairman | Antonio Bari | Italy | antonio.bari9@gmail.com |
| Vice Chairman | Gus Wirth | USA | gwirth79@gmail.com |
| Chief Measurer | Luis Gonzales Alvarez | Spain | lugoal69@gmail.com |
| Members | Masakazu Sasai (2019/20) | Japan | m.sasai30850@gmail.com |
| | Mario Eugenio Tavares | Brazil | meugeniot@gmail.com |
| | Arild Figenschou | Norway | arild.figenschou@akersolutions.com |
| | Mariano Arroyo (2020) | Argentina | arrojomariano@hotmail.com |
| | Luis Soubié (2017/19) | Argentina | |
| | Nobuhiko Kudara (2017/19) | Japan | |
| Chief Information Officer | Don Bedford | USA | bedfordd@gmail.com |

The Measurement Process

- boat produced
- measured by certified measurer
- installation of measurement stickers on boats by a National Measurer only
- Measurement Data Sheet completed: original sent to SCIRA office, copy to NS with measurer
- Measurement Certificate given to owner

How to Measure a Snipe will be included in another section of this handbook, with details, photos, etc. of measuring a Snipe.

Extract from SCIRA By-laws

Section 5. Measurement

Each boat, to be eligible to race, must hold a Certificate of Measurement recommended by the Measurer and approved by the Rules Committee of the Association. To obtain such a Certificate the boat must be examined by the Measurer who shall report his findings on a Snipe Class Measurement Data Sheet currently approved by the Rules Committee. If the boat complies in all respects the Measurer shall fill out a Measurement Data Sheet (MDS) and send one copy of the same to the National Secretary with the owner's current dues and the original to SCIRA Office. The owner then becomes a member of the Association.

Section 6. Measurer's Duties

It shall be the duty of a Measurer to call to the attention of the Association any and all discrepancies not found to be within the tolerances shown on the current Measurement Data Sheets. Any discrepancy found on a professionally built boat shall be corrected before a certificate is issued. In case there are discrepancies on a home built boat, and if (in his opinion) the discrepancies are of minor importance of the boats sailing qualities, the Measurer may give a Limited Measurement Certificate good only for Club or Fleet races provided such discrepancies are clearly indicated on the Data Sheet. However, final decision shall rest with the Chief Measurer. Boats holding a Limited Measurement Certificate shall not race in any Sanctioned regatta or Major Championship.

When the Fleet Measurer is the owner of a Snipe, he should be the chairman of a committee for measuring boats and recommending issuance of Measurement Certificates. No person may take or record the measurements of a Snipe in which he is financially or otherwise interested. The Association may refuse to accept further recommendations for Measurement Certificates from any Measurer or committee that is found guilty of negligence or misrepresentation regarding measurement.

Section 7. Measurement Fee

Measurement fees are fixed by the Fleet or by the Measurer with the approval of the Fleet. Of this fee the amount specified for each country shall go to the National Secretary, together with Measurement Data Sheet, which sum will be considered as the owners' dues for the ensuing year.

Section 8. Measuring Unattached Boats

Boats may be owned in localities where no fleet is in existence. The owners of such boats may, upon application to the National Secretary, receive a Measurement Data Sheet to be filled in relative to the boat, appendages and rig. Upon returning this to the National Secretary, together with Class dues, a Provisional measurement Certificate will be issued provided the boat appendages and rig are found to be within the limits of the Class. This Provisional Measurement Certificate shall be subject to ratification by an accredited Measurer who shall re-measure the boat and who shall be empowered to recommend a full Certificate of Measurement. Provisional Measurement Certificates will not permit a boat to take part in any qualifying regatta or major Championship.



Measurers Role

Boats are measured principally to establish compliance with the class rules, but there are different cases when compliance is checked and the role of the measurer varies in each case.

Racing Rules and Measurement

Racing Rule 78 – Measurer’s Responsibility

This rule lays down the procedure which a measurer is to follow when he finds that a yacht does not comply with the class rules.

The rule reads:

- 78 Compliance with Class Rules, Certificates
- 78.1 While a boat is racing, her owner and any other person in charge shall ensure that the boat is maintained to comply with her class rules and that her measurement or rating certificate, if any, remains valid. In addition, the boat shall also comply at other times specified in the class rules, the notice of race or the sailing instructions.
- 78.2 When a rule requires a valid certificate to be produced or its existence verified before a boat races, and this cannot be done, the boat may race provided that the race committee receives a statement signed by the person in charge that a valid certificate exists. The boat shall produce the certificate or arrange for its existence to be verified by the race committee. The penalty for breaking this rule is disqualification without a hearing from all races of the event.
- 92 Technical Committee
- 92.1 A technical committee shall be a committee of at least one member and be appointed by the organizing authority or the race committee or as prescribed in the World Sailing Regulations.
- 92.2 The technical committee shall conduct equipment inspection and event measurement as directed by the organizing authority and as required by the rules.

When a measurer for an event decides that a boat or personal equipment does not comply with the class rules, he shall report the matter in writing to the race committee, which shall protest the boat.

It is important to note that the measurer has no authority to disqualify a yacht or to rescind its entry.

A measurer is sometimes called upon to report on the circumstances of a protest to a Protest Committee (or to an International Jury). This report should record only the facts – i.e. the measurements or details of the shape of the item concerned and, if requested, the wording of the class rules.

The Protest Committee may decide the protest after a hearing, if it is satisfied there is no reasonable doubt as to the interpretation or application of the class rules. However, if it is not so satisfied, the protest committee is required to refer the matter to an authority qualified to decide the matter.

The racing rules do not make it clear on who such an authority is and therefore the protest committee or international jury can decide which authority it consults. World Sailing Regulation 26.11 covers Interpretation Procedures. For the Snipe Class, the Chairman of the International Rules Committee is considered to be the ultimate qualified authority.

Application of Class Rules

A measurer must be completely conversant with the Class Rules in order to apply them correctly. To properly use Class Rules the measurer must understand and follow the general administration rules as well as the specific measurement rules.

Objectives of Snipe Class Rules

Snipe hulls, hull appendages, rigs and sails are measurement controlled. Equipment is required to comply with the International Snipe Building Specification.

Measurement procedures and tools are explained in the Measurers' Handbook furnished by SCIRA. Snipe hulls, hull appendages, rigs and sails may, after having left the manufacturer, only be altered to the extent permitted in Section C of the class rules.

Rules regulating the use of equipment during a race are contained in Section C of the class rules, in Equipment Rules of Sailing (ERS) Part I and in the Racing Rules of Sailing. Owners and crews should be aware that compliance with rules in Section C is not checked as part of the certification process.

THE RULES ARE CLOSED CLASS RULES WHERE IF IT DOES NOT SPECIFICALLY SAY THAT YOU MAY – THEN YOU SHALL NOT.

Hull Certification

A.12 INITIAL HULL CERTIFICATION

A.12.1 For a certificate to be issued to a hull not previously certified:

- (a) Equipment certification measurement shall be carried out by an official measurer who shall complete the Measurement Data Sheet (MDS) provided by SCIRA.
- (b) The MDS and certification fee, if required, shall be paid to the Measurer.
- (c) Upon receipt of a satisfactorily completed MDS, the Certification Authority may issue a certificate.

A.13 VALIDITY OF CERTIFICATE

A.13.1 A hull certificate becomes invalid upon:

- (a) The change to any items recorded on the hull certificate as required under A.11 or the MDS.
- (b) Withdrawal by SCIRA or NCA,
- (c) The issue of a new certificate.

A.13.2 Hulls built before January 1st 1976 that have not been modified in their shape or materials need not be recertified.

A.14 HULL RE-CERTIFICATION

A.14.1 The Certification Authority may issue a new certificate to a previously certified hull:

- (a) When the certificate becomes invalid under A.13.1(a) after receipt of the old certificate and certification fee, if required,
- (b) When it is invalidated under A.13.1 (b), at its discretion.
- (c) In other cases, by application of the procedure in A.12.

Special procedures in measurement

For measurement for certification, the measurer must refer to the class rules current at the time of measurement. However, hull re-measurement and measurement of repairs rebuilds are normally to be made in accordance with the class rules that were in effect when the boat was first measured for certification. This is often known as the "grandfather clause" and may necessitate researching to find out what the rules were some years in the past. If in doubt, contact the SCIRA office.

Amendments to Class Rules

The International Rules Committee is constantly trying to update and improve the Snipe Class rules. Any amendment or change to the Class rules after the approval of the Board of Governors is subject to the approval of World Sailing in accordance with WS Regulations. Any change in the Class rules is published on the SCIRA website and in the online Snipe Bulletin

Interpreting or clarifying Class Rules

There will be occasions when the meaning of a class rule is not clear to the measurer. When measuring for certification the measurer should contact the Chief Measurer or International Rules Committee Chairman for

clarification before signing the Measurement Data Sheet (MDS) and describe on the MDS what he has found, so the SCIRA office can alert the Chief Measurer to determine whether a measurement certificate is to be issued or not.

All rules interpretations are made in accordance with the World Sailing Regulations. Decisions of the Rules Committee are published on the SCIRA website and in the online Snipe Bulletin.

The Class Rules are published on the SCIRA website: www.snipe.org and on www.sailing.org/28237.php

Effective date:
Status:



Class Rules

Snipe Class International Racing Association: 2018-2020



The Snipe was designed in 1931 by William F. Crosby and was adopted as a World Sailing class in 1932.

sport / nature / technology



Measurer's Supplies

Tools Needed for Measurement

- SCIRA provided measurement tools (see handbook)
- Pencils
- Permanent markers
 - thin tip
 - fat permanent marker for daggerboard stripe and/or limiting marks
 - permanent paint pen for use with measurement stickers
- Tape Measurer
- Level
- High quality adjustable square
- Calibrated Weight scales:
 - fish scale for weighing rudder & mast
 - large scale for hull

Items Available from the SCIRA Office for Measurers:

| | Fleet Measurer | National Measurer | National Secretary | International Measurer |
|---------------------------------------|-----------------------|--------------------------|---------------------------|-------------------------------|
| Rulebook | √ | √ | √ | √ |
| Measurement Stickers/pen | | √ | | √ |
| Measurement Certificates-blank | | | √ | √ |
| Measurement Data Sheet-blank | | √ | | √ |
| Measurer's Stamp | | | √ | √ |

The following items can be requested through the SCIRA office by the National Secretary:

- Measurement stickers: specify
 - Small: equipment
 - Large: hull
- Moment of Inertia springs \$75.00
- Sail Royalty labels \$ 5.00
- New hull numbers \$50.00
- Paint pen markers 1 per measurer

Equipment inspection at events

The following are the minimum equipment inspections to be conducted at each level of event:

Sanctioned Regattas:

- verify that the boat has the SCIRA decal
- verify that all sails are measured and have the royalty labels
- verify the safety equipment: 2 personal flotation devices, a paddle and a single piece floating towing line of 15 meters length by 8 mm diameter

National and International Championships:

- National and International Championships: boats are required to check sails stamps, decals, paddle, tow line and personal flotation devices at minimum, unless differently stated in the appropriate DoG. No more than two suits of sails per boat may be measured. It is strongly suggested to use a stamp of the championship. Ensure the proper sail cloth is being used. The same boat and measured equipment must be used throughout entire event. Petitions for replacement of irreparably damaged equipments shall be addressed in writing to the Race Committee.
- Other championships: in addition to the lower level are required to inspect boats according to the specifications below:
 - **Level 1**- North Americans, South Americans and National Championships: correctors weights, daggerboard safety line and retaining system, mast step.
 - **Level 2** - WE&O and Open European Championships: weight, sails, daggerboard, jib tack.
 - **Level 3** - World Championships: rudder, mast, boom, pole.

At Level 2 and 3 Championships the measurement committee may also:

- fully measure at least one hull of each builder
- check MOI

At discretion of the Measurement Committee of the event, one or more of the measurements of the higher level of competition may be requested, providing it is indicated in the Notice of Race.

At Championships the measurement committee acts as equipment inspector. Thereafter the boat cannot be modified in a manner in which would require re-measurement.

Event Chief Measurer Responsibilities

Whether it is a national or international regatta, the following should be observed and organized:

Timeline & Venue Requirements

- Begin contact with the SCIRA office to obtain contact information for the Chairman of the regatta. Establish the dates of measurement in coordination with the Organizing Committee, SCIRA office and SCIRA Representative for publication in the Notice of Race.
- Establish individual inspection stations for the following:

| Snipe Equipment | Measurement Equipment Required | # Volunteers Required |
|---|---|-------------------------------------|
| Hull Weight MOI – if necessary | For weighing of the hull, a calibrated scale and area protected from the wind is essential. A similar area will be necessary if the MOI test needs to be performed. | Measurement: Weight: 2 MOI: 3 |
| Rig: mast, boom, whiskerpole | A long table, suitable for the length of the mast is necessary | 2 |
| Appendages: rudder, daggerboard | A table large enough to measure the rudder & daggerboard | 2 |
| Sails | Protected area to measure sails: large enough for a Snipe mainsail to be unfolded | 3-4 |
| Administration | 1 table for check-in/out | 2 |

- Determine with Organizing Committee how measurement will be scheduled. Various methods include: first come, first served; by country; by bow number; by appointment.
- Ask Organizing Committee to include Measurement Verification Sheet (see Appendix) in each competitor registration packet.
- Create measurement staff to assist during measurement with assigned positions. Provide each measurer with the measurement rules for their equipment and go through measurement process with all at meeting held before measurement opens.

Equipment Details

Sail Inspection Table:

- large enough and at waist height to accommodate an unfurled mainsail.
- Head of main & jib at control point: dimension drawing at top corner of table and layout all the maximum dimensions radiating from the head point.
- Layout all the tack, head and clew corner dimensions just inside of the maximum length limits
- Battens: layout the 3 batten length maximums on the table.

Appendages:

- use a table large and mark limiting marks on table or use templates taped down.
- Set and screw for the rudder datum point on the template as well as a control pin low on the leading edge. Draw the max and min dimensions of the blade or use a mylar or hard template.
- Prepare a line to hang a scale for weighing rudder.
- Set two control pins to locate the daggerboard in the template. Screw down one pin at the bottom edge of the template and the other on the aft edge limit near the top of the daggerboard template, allowing quick and accurate positioning.

Rig:

- full table is needed to support the aft end of boom
- Make cutouts for shrouds attachments and spreader bracket so that the mast will lay flat on table.

- Mark all control marks using the butt of the mast as the control point.
- Prepare a line to attach a scale above the table roughly at the spreader bracket, to weight and check the balance of the mast. (note: for pre-2001 boats, the control point will be the sheer point. Use different color markers for sheer marks.
- Take boom measurements with a tape measurer rather than laying out limiting marks on table.

Suggested Method:

1. roll boat into measurement area & check-in.
 - a. MDS checked against hull number
 - b. SCIRA sticker verified
 - c. Safety equipment checked
 - d. Bow numbers checked
2. Remove all equipment not allowed in boat during weigh-in
3. Sails taken to measurement table
4. Boat weighed, MOI'd if needed.
5. Appendages and rig taken to respective stations for measurement.
6. Attach measurement stickers and/or stamps (if being used) at each station.
7. Return to check-out station where Inspection Verification Sheet is checked for completion & signed. Competitor takes IVS to registration.

Regatta Schedule

- Competitor receives Inspection Verification Sheet (IVS) in registration packet
- Inspection appointments posted on official notice board
- Competitor completes inspection process & returns IVS to registration desk

Chief Measurer Responsibilities during Event

- Organize measurement team
- Organize venue physical requirements
- Conduct Inspection process overseeing assistants
- Verify all IVS before racing begins and file for possible use during the event
- Be available for measurement questions throughout event (check with SCIRA Representative on this.)



The Measurement Process

- boat produced
- measured by certified measurer
- installation of measurement stickers on boats by a National or International Measurer only
- Measurement Data Sheet completed: original sent to SCIRA office, copy kept with measurer
- Measurement Certificate given to owner

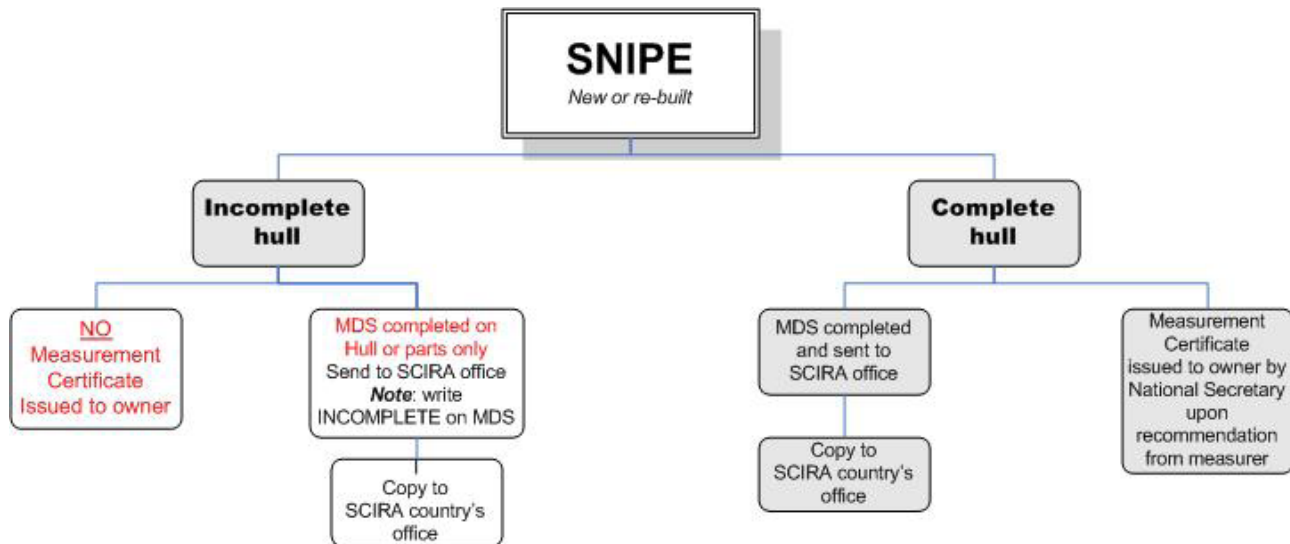

Measurement Data Sheet (MDS)

The Measurement Data Sheet (MDS) is the official measurement form completed on all boats built. The MDS is the permanent record for a boat. If a boat is sold and perhaps moved to a new country, the MDS remains in the SCIRA office for reference. These forms have been modified over the years and are referred to alphabetically as “sheet A” etc. based upon the year the boat was built. Newer versions are based upon rules changes passed by the Board of Governors. The MDS consist of two parts.

Part 1 records all the measurements of the boat. It is completed if the boat is build from non-certified molds or to renew the Cerification according to the Builders’ Certification Rule.

Part 2 records the variable measurements and is completed for all boats. A new boat will be measured under the most current MDS while an older boat, not refurbished, will be measured under the Part 1 of the MDS of the year it was built and Part 2 of the current MDS (or according to the appropriate MDS).

Certified builders shall complete a full MDS any ten boats manufactured or once a year (which is shorter)

SCIRA MDS Rev. 7-07 - July 2019

SCIRA Measurement Data Sheet
To be used with the 80/20 true baseline measurement frame
For boats built from January 1st, 2018. For older boats use the MDS in force in the year of manufacturing

Owner _____ Date: _____
Hull _____ Builder _____ Material _____

NEW MOULD: FIRST OR OF 5 CERTIFICATION RENEW Y/N
DO NOT COMPLETE IF FROM A CERTIFIED MOULD

| Chine | | | | | | |
|---------|-----------|------|--------|-----------------|--------|-----------------|
| Station | Starboard | Port | Height | | Width | |
| | | | Total | Allowable Range | Actual | Allowable Range |
| 1 | | | | 836-864 | | 527-548 |
| 2 | | | | 734-749 | | 966-1000 |
| 3 | | | | 673-699 | | 1233-1248 |
| 4 | | | | 690-738 | | 1270-1280 |
| 5 | | | | 763-787 | | 1137-1149 |
| Transom | | | | 903-927 | | 952-966 |

| Sheer | | | | | | |
|---------|-----------|------|--------|-----------------|--------|-----------------|
| Station | Starboard | Port | Height | | Width | |
| | | | Total | Allowable Range | Actual | Allowable Range |
| 1 | | | | 1499-1540 | | 895-923 |
| 2 | | | | 1391-1441 | | 1346-1372 |
| 3 | | | | 1300-1394 | | 1511-1557 |
| 4 | | | | 1203-1272 | | 1473-1489 |
| 5 | | | | 1103-1272 | | 1270-1286 |
| Transom | | | | 1044-1436 | | 1022-1048 |

Snipe Class International Racing Association

How to Complete a MDS

The measurer is asked to check to ensure the boat being measured is a legal Snipe. Therefore, all areas must be checked and individual numbers circled to ensure accuracy. If an area does not comply with the rules, then a note must be made on the MDS. All information must be completed. A certified measurer must sign and date the last page if the boat has passed measurement. Use the SCIRA stamp to complete the application.

If a boat does not pass measurement, any irregularities must be noted on the MDS and the form should not be signed. Forward the MDS to the SCIRA office for filing.

Bare Hull or Partial Measurement

If you are asked to measure a hull that is being delivered without equipment or partial equipment, measure the hull to ensure that it is a Snipe. Make a notation on the last page for missing equipment such as:

- Bare hull only
- Mast, boom missing
- Appendage missing, etc.

Where to Send

When the MDS is completed or completed as much as possible, the original MDS shall be mailed to the SCIRA office for permanent keeping and a copy to the National Secretary. A copy may be kept with the measurer for safekeeping.

| Keel | | | | | Stem Offset | | |
|--------|--------|-----------------|--------|-----------------|---|---------------|--------|
| Stops | Height | | Width | | Up from baseline | Back from HDP | Actual |
| | Actual | Allowable Range | Actual | Allowable Range | | | |
| 400mm | | 223-235 | | | 247 | 247-279 | |
| 1 | | 162 | | Min 51 | 306 | 194-206 | |
| 2 | | 40-50 | | 99-103 | 317 | 183-195 | |
| 3 | | 51-63 | | 99-103 | 381 | 130-130 | |
| 4 | | 59-70 | | 99-103 | 407 | 54-66 | |
| 5 | | 54 | | 99-103 | 527 | 38-50 | |
| Teesom | | 184-178 | | 99-103 | 333 to 347 interaction of chine extension | | |

| Miscellaneous | | | | | |
|--------------------------|--------|-----------------|-----------------------------|--------|-----------------|
| Measurement | Actual | Allowable Range | Measurement | Actual | Allowable Range |
| LOA | | 4716-4728 | Chine radius at st. 1 | | Max 19 |
| Horizontal teesom offset | | 280-229 | Chine radius at 2 to teesom | | Max 3 |
| Hull Datum Point Height | | 440-506 | Deck height | | Max 127 |
| Race radius | | Max 25 | Cockpit width | | Max 306 |

| Topside Measurements | | | | | |
|--|--------|-----------------|-------------------------------|--------|-----------------|
| Measurement | Actual | Allowable Range | Measurement | Actual | Allowable Range |
| All end of dagger slot from Hull datum point | | 2430-2466 | Mid point to sheer (vertical) | | 290-400 |
| Top of case parallel to baseline | | tolerance 2 | Mast hole in the deck | | Max 20/21 |
| All side of case perpendicular to baseline | | tolerance 2 | Length of foredeck | | Min 1042 |
| Forward edge of case perpendicular to baseline | | tolerance 4 | Length of aft deck | | Min 457 |
| Case to top of daggerboard case | | 310-263 | Shear strakes | | Max 32 |
| Length of daggerboard slot | | Max 646 | Gurwale radius | | Max 32 |
| Width of daggerboard slot | | Max 13 | Daggerboard | | Min 93 X 493 |

Measurer _____ Stamp no. _____
 Snipe Class International Racing Association

SNIPE CLASS RACING ASSOCIATION
 MEASUREMENT DATA SHEET FOR CERTIFIED BOATS
 Revised February 2019

*This page to be used for all boats. For measurements in **italic** refer to the Class Rules*

HULL NUMBER _____ BUILDER _____
 MODEL _____ YEAR OF MANUFACTURE _____
 OWNER _____ COUNTRY _____

BARE HULL COMPLETE INCOMPLETE
 HULL MATERIAL: WOOD FIBERGLASS make note of incomplete items
 DECK MATERIAL: WOOD FIBERGLASS filling the cells with **NO**

FROM CERTIFIED MOULD

WIND WEIGHT (min 125kg) _____ MAST JUNCTION (Rule C.8.2, E.2.4) _____
 TOTAL WEIGHT (min 172.8kg) _____ Lashing marks & pin _____
 CORRECTOR WEIGHTS (max 15kg) _____ Corrector weights (max 100gr) _____
 MDC _____ BOOM LENGTH (max 2643mm) _____
 Spring set # _____ Lashing marks & pin _____
 JIB FITTING _____ POLE LENGTH (max 2642mm) _____
 (279-308mm hoc from Hull Datum Point) _____

RUDDER DIMENSIONS _____
 max 43mm vert. above sheerline) _____ Weight (min. 2,72kg) _____
 SHROUDS (1779-1961mm from HDP) _____ Corrector weights (Rule C.8.5) _____
 MAST HOLE (min 5494mm from HDP) _____ Parallel to teesom (tolerance 2mm) _____

UPPER GUNGEON (Rule D.2.1) _____ DANGERBOARD DIMENSIONS _____
 LOWER GUNGEON (Rule D.2.1) _____ Band _____
 GUNGEON DIAMETER (Rule D.2.1) _____ Safety line (max 63mm long) _____
 Restraint system (hooks or tabs) _____

Insert the actual measurement in the cells marked as
 Mark corrector weights position and amount below. Data to be copied on the Official Snipe Label

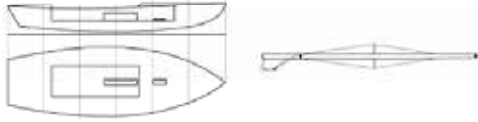

DATE MEASURED _____ MEASURER'S STAMP _____
 MEASURER'S NAME _____
 NOTES: _____

Snipe Class International Racing Association

Measurement Certificate

A Measurement Certificate is a miniature of the MDS that is given to the owner of the Snipe. This is the owner's proof that the boat is a legal Snipe and presentation of the Measurement Certificate at regattas will aid in the registration and measurement process.

Once a MDS has been completed, the measurer shall send the necessary data to the National Secretary who will issue the Measurement Certificate. The minimum information a MC shall display are:

- (a) Class.
- (b) Number of Measurement Certificate (Optional).
- (c) Hull number issued by SCIRA.
- (d) Builder/Manufacturers details.
- (e) Owner's name and address.
- (f) Country of registration.
- (g) Total weight of the boat.
- (h) Location and amount of the corrector weights (hull and mast).
- (i) Moment of Inertia.
- (j) Measurer's name and stamp.
- (k) Date of issue of the initial certificate.
- (l) National Secretary name & stamp.
- (m) Owner's signature

Lost or Replacement Measurement Certificates

If an owner should lose the Measurement Certificate for his boat or, application should be made to the National Secretary or SCIRA office for a new one.

In case the boat is sold to a new owner, the National Secretary shall be informed.

Any change in the boat weight, MOI, mast shall be recorded on the MC and the National Secretary informed to keep record of the changes.

 **Snipe Class International Racing Association**
MEASUREMENT CERTIFICATE N. _____

Hull number _____ Year of construction _____

Builder _____ Model _____

Weight _____ total corrector weight less

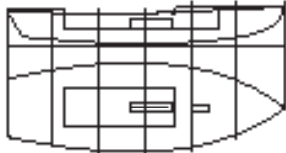
Corrector weights _____ 

Mast builder _____

Corrector weights _____

Mast value _____ 

Owner _____ Country _____

Measurer's _____ SCIRA stamp _____

Date of measurement _____

This certificate is not valid until signed and stamped by the N.S. This certificate indicates that the boat has a registered MDS on file at SCIRA office.

National Secretary stamp and signature _____

I hereby agree to all SCIRA rules and by-laws. I agree to notify a SCIRA measurer if any equipment is modified, repaired and/or transferred to proceed to a new measurement.

SCIRA reserves the right to measure this boat and any equipment at any time.

Owner signature _____

Date _____

THIS CERTIFICATE REMAINS WITH THE OWNER OF THIS SNIPE.
IT CAN BE REPLACED BY REPLACEMENT.

Measurement Stickers and Labels

Each National measurer is provided with an inventory of measurement “void” stickers for identification of equipment that has passed measurement. These stickers are marked by the measurer with a permanent paint pen with the hull # and date of measurement. If the sticker is attempted to be removed, it will leave the word “void” on the equipment to prevent the sticker to be placed elsewhere.

The small stickers are to be placed on the following pieces of equipment:

- Mast
- Boom
- Rudder
- Daggerboard
- Whiskerpole

The larger stickers are to be placed in the aft portion of the cockpit with the corrector weights placement clearly marked on the hull diagram as well as the hull # and date of measurement. The purpose of this is to give anyone a quick inspection of corrector weights and amounts.

The measurement stickers are UV protected, so they should last in the sun and normal sailing conditions.

In addition, royalty sails labels shall be applied to every sails before they are measured according to the following Class Rules:

1. A SCIRA sail royalty label shall be permanently attached on any mainsail and jib by the sailmaker. Royalty labels shall be purchased by the builder from SCIRA
2. A stamp shall be imprinted by the sailmaker at the top of the mainsail and jib to certify the weight of the sailcloth

The measurer shall not approve a sail without a royalty label applied. He then will mark the sail on the starboard tack with his signature and SCIRA, MNA or WS stamp.

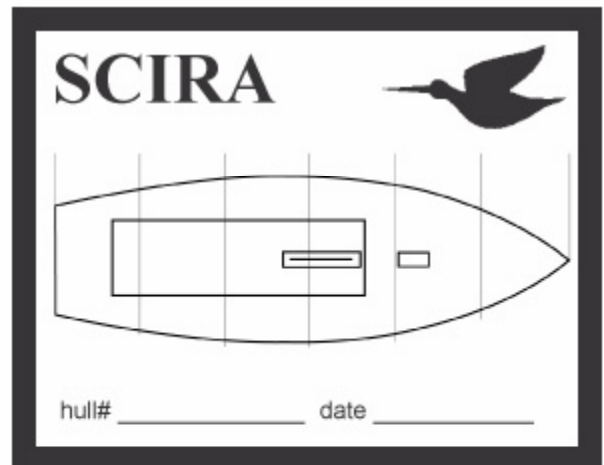

How to Measure a Snipe

The following instructions are to be used to measure new Snipes using the 80/20 sliding arm measuring frame

Snipe measurement frame assembly instructions

The Snipe measurement frame when assembled correctly will provide the measurer with a very accurate tool that is easy to place on the hull and operate. The frame is designed so that it may be easily stored, shipped and assembled. The measurer and an assistant should be able to set up the frame in about 15 minutes if the frame is completely disassembled. The materials and fasteners are all Standard English (US) measurements and dimensions, so it is necessary to have the following tools.

1. Ball end Hex wrenches in 5/32, 3/16 and ¼
2. A ½ open end wrench
3. Three saw horses to support the frame during assembly and storage when it is not in use.

The frame includes the following parts;

| PART | DESCRIPTION |
|------|--|
| 01 | Front ½ main beam |
| 02 | Back ½ main beam |
| 03 | 3 barbell connecting lugs |
| 04 | center leveling foot |
| 05 | Station 1 stabilizing feet with longer rods |
| 06 | Station 1 mounting foot |
| 07 | Station 5 mounting foot |
| 08 | Station 5 stabilizing feet with shorter rods |
| 09 | Hull Datum Point fin |
| 10 | Cross member |
| 11 | Keel height / station locating rod |
| 12 | Assembly Tools & Class Rules |

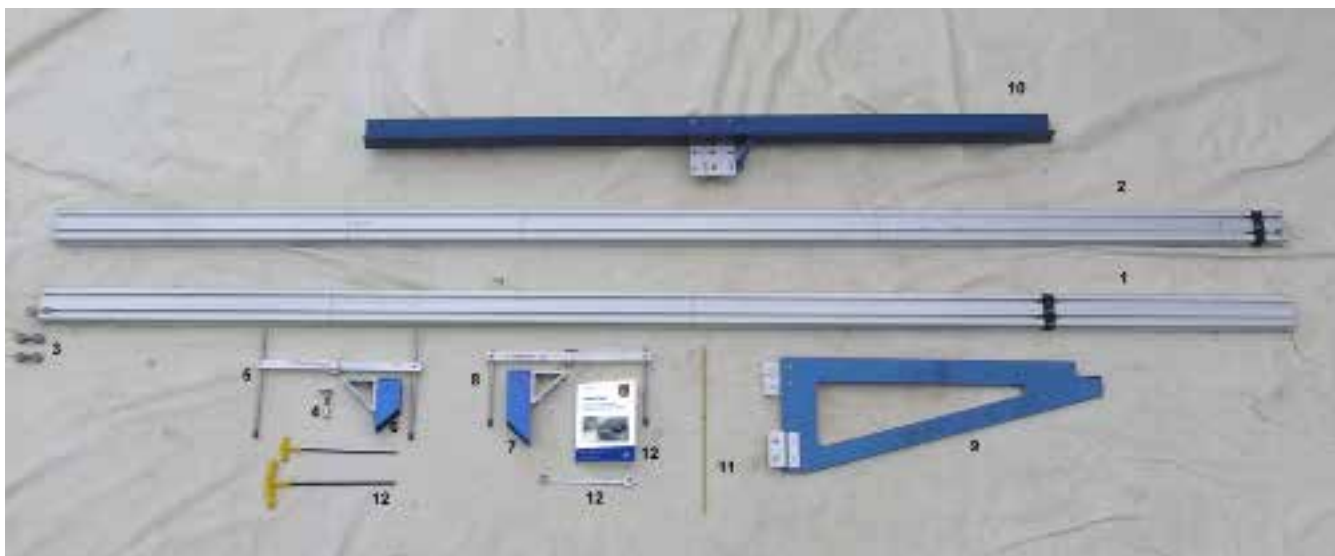

1. Line up part the 1 and 2 main beams so that the connecting lug holes match up to each other and insert the lugs (parts 03) and hand tighten. The use of a saw horse at each end of the frame and a third at the connection point will make assembly easier and save your back. Align the grooves so that they match each other as closely as possible. Now tighten all lugs very snugly. Note; one of the barbell lugs (part 03) has been ground smooth across the top of its face, this lug should be used on the top lug hole so that the cross member (part 10) may slide cleanly across the connecting joint.
2. Slide the leveling foot onto the aft end of the frame and push it forward to just aft of the Dagger board stripe.
3. Slide the stabilizing feet (part 5) onto each end of the frame followed by the station 1(part 06) mounting foot. Position the mount so that the long edge is exactly at the station one line. Tighten the two screws of the mount into the frame. Check to be sure that the foot is still properly positioned. Slide the stabilizer up against the mount and tighten. Make sure that the stabilizer is square to the frame.
4. Repeat step 3 for installing the station 5 mounting foot (part 07) and stabilizer feet (part 08).
5. Slide the hull datum point fin (part 9) onto the frame and hand tighten. Verify that the fin is exactly at the hull datum point mark. Tighten the four screws snugly.
6. Double check stations 0, 1 and 5 to ensure the parts are installed and aligned exactly on their respective stations.
7. You are now ready to flip the frame right side up and slide the cross member onto the frame.
8. Slide the cross member (part 10) onto the frame. Be sure that the blue lock handle is released. Slide the cross member back to station one and insert the keel height locating rod (part 11), now lock the blue handle. The locating rod should slide cleanly through the cross member and frame, this places the cross member exactly on the station.
9. Check to make sure that the cross member is exactly 90° to the frame on the horizontal plane. Make adjustments as needed. Tip; if adjustment is necessary leave the locating rod in place so that there is clean pivot point.
10. Place the frame onto the upside down hull and positioned correctly at The hull datum point. Sight down the frame to note any sag in the middle of the frame. If there is any sag use the center leveling foot (part3) to correct by twisting the barrel so that the sag is removed.
11. Adjust the stabilizer feet (part 5 and 8) so that the frame will not rock side to side.
12. You finished with assembly. Good luck with your measurements and THANK YOU for volunteering to be a SCIRA Measurer.

The 80/20 frame and related tools when used correctly, will ensure extremely accurate measuring of a Snipe hull. The frame consists of a main beam which carries a sliding car and a cross member. The cross member has a locating point for each of the five stations, these stations are located 787 mm apart at each station. The vertical fin at the front of the frame represents station zero (hull datum point). The frame sits on top of the overturned hull at two fixed points and one optional adjustable point. The two fixed points are at stations one and five. These two blocks are pre set so that the lower edge of the frame is at the base line (reference line) of the hull. The third optional point is solely to correct any sag in the Frame.

Remember that all the vertical measurements of chine and sheer to fill in the MDS are to be taken from the upper part of the cross member.







Tools

There are eight additional tools (see photo) needed for use with the frame as follows;

- 1 The locating rod which is used to lock in the five station points, transom points and the point 400 mm aft of the hull datum point.
2. An 1800 mm caliper used to take all beam and width measurements.
3. A straight edge with an adjustable grooved block for locating and measuring sheer heights and locating chine edges.
4. A zero point locator, this important piece is used to find the hull datum point at the stem of the Snipe.
5. the bow radius tool, this bar is used to check for the correct shape of the bow.
6. Two right angle triangles used to measure transom chine, sheer, length and offset.
7. A straight locator tool used to mark various points.
8. A sheer locating tool used to find the sheer points along the deck/ hull intersection.

Other tools you will want to have available are a high quality adjustable square, tape measurer and level. It is VERY important to have several sharp pencils to mark the various points on the hull.

The above tools have the proper dimensions and shapes approved by the Rules Committee. All Snipes and equipment shall fit to these tools and NOT tools to the boat.

Official tools shall not be modified.

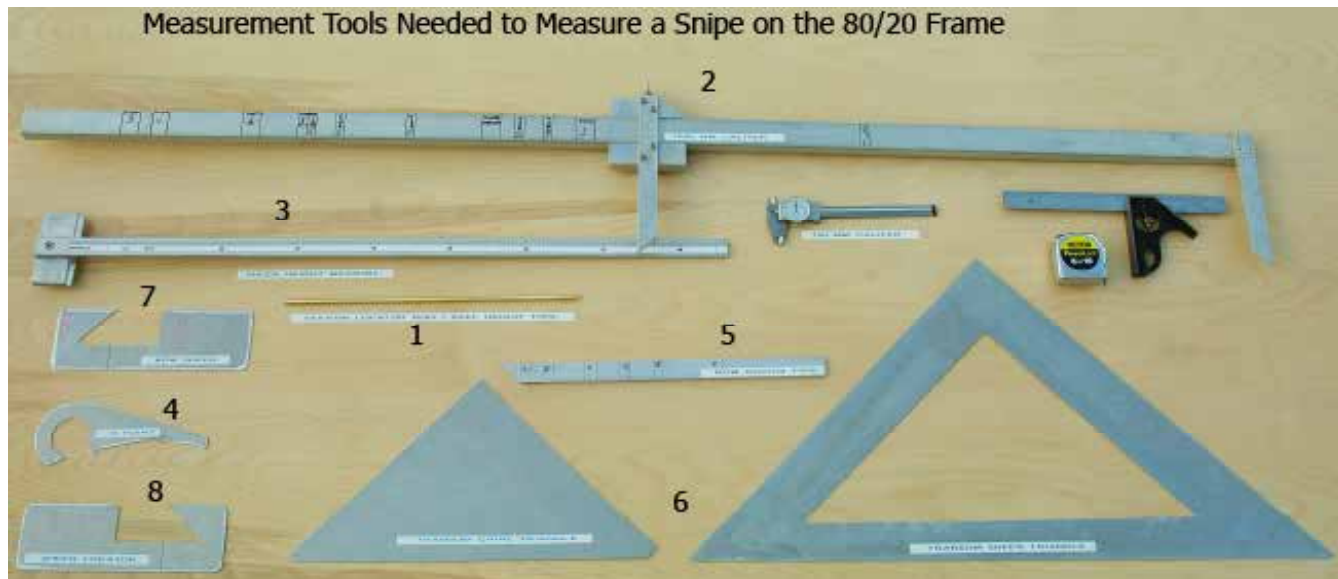

Hull Measurement

This section on hull measurements has been written and photographed for use with the 80/20 measurement frame or any frame where the lower edge of the main beam is the base line.

Hull Datum Point:

Finding the Hull Datum Point is simple: place the tool on the stem edge of the hull so that the point is resting on the top of the deck. It is best to find the Hull Datum Point before the boat is turned upside down. To exactly mark the point use a carbon copy sheet. [See Photo](#)



Frame Positioning:

Set the measurement frame carefully onto the keel so that the vertical edge of the fin (this is the zero point of the frame) is exactly on the Hull Datum Point of the hull stem. Use the stem tool to help in aligning the frame remembering that the stem tool must stay in column with the fin to achieve proper positioning.

Once the frame is set at zero adjust the leveling feet so that the frame is secured and cannot fall off the hull. Recheck the Hull Datum Point and we are ready to measure the hull.

Stem Height:

With the stem tool check the stem height, it must be within the shaded area on the fin or between 683-708 mm up from the base line. [See photo.](#)



Stem Offset Measurements:

Starting at the stem [point A or 527mm up from the base line] measure from the zero point on the measurement frame fin to the bow. The measurement shall 26-32 mm or between the marks labeled A on the bow radius tool. Make sure that you are recording each of the values as you measure.

Proceed to point B or 457 mm up from the stem and take the measurement and repeat for each of the points [C - F]. Take the measurement for the Chine intersection which is marked on the tool and fin or between 311-387mm. If the chine is not visible because rounded, use a 1mt long flexible batten to extend it to the bow.

Measure back from frame fin 400 mm and measure the keel height [223-235mm] or thru the first locator hole on the measurement frame.

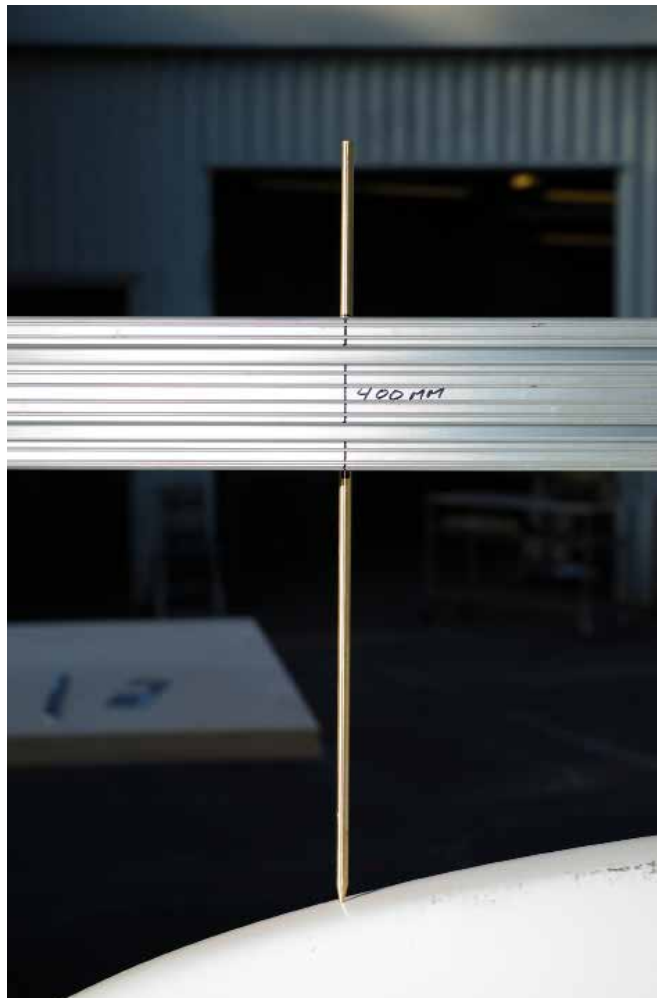

Station Measurements:

Slide the cross member back to the line marked station 1. Drop the locator rod thru the hole at station 1 on the frame [be careful, don't drop the rod as you will definitely put a punch mark on the keel] and then lock the cross member. Locking the cross member will ensure that the cross member is 90° to the frame. With the rod in place note that only one of the two scribe marks are visible.

See photo.

Measure the width of the keel flat with a tape measurer and record the value on the measurement sheet. The keel flat shall be max. 102 mm aft of station 2. The keel may start to taper at station 2 to the bow, however the taper must be no less than 51mm at station 1. This measurement is to be taken on the outside of the keel

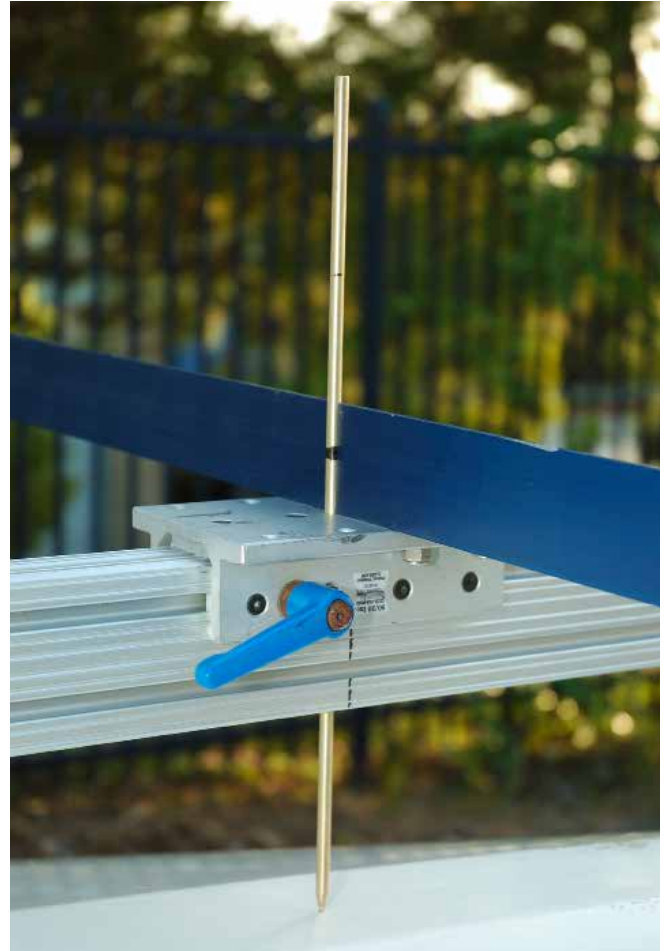

Measure down from the bottom edge of the cross member to the chine on each side and record the measurements on the measurement sheet **fig 1**. For the sheer line measurement use the sheer tool and the squared edge to locate and mark the station location longitudinally on both the sheer line and the chine (these will be absolutely necessary for finding the width measurements).



Now find the sheer line measurement point by placing the sheer locator tool against the side of the hull with the pointed end hooking over the gunwhale and the point resting on the deck. Use a carbon copy sheet to mark the line **See photo.**



Make a pencil mark at this point now pivot the tool so that it is parallel to the locator tool which should be hanging 90° to the cross member. **See photo.** (needless to say this is tricky at first).

Take the measurement reading from the black scribed line on the locator tool to the nearest millimeter and record the value on the measurement sheet. Repeat this process on the opposite sheer line. Remember that the measurement shall be taken from the top of the cross member.

Now unlock the frame remove the rod and slide the cross member aft to station 2. Insert the keel rod and lock the cross member. Repeat the same process performed on station 1 for stations 2 through 5. Be sure to record the measurement values onto the Measurement Data Sheet.





Dagger Board Case Measurements:

Using the transom sheer triangle or a large square, lower one end into the aft edge of the daggerboard slot and the other edge against the lower edge of the measurement tool to measure the maximum aft opening. **See photo at right.** This opening shall be between 2438 and 2464 mm aft of the stem or within the black band on the measurement tool. Also check that the aft edge of the slot is perpendicular to the base line of the measurement tool with a tolerance of 2mm at the top. The length slot shall be no longer than 546mm and no wider than 13mm. The front should be perpendicular with a tolerance of 6mm at the top of the daggerboard case.

This next measurement only applies to hulls built after 01 January 2001. Measure the depth of the trunk at the aft edge, this measurement shall be between 310 and 313 mm from the bottom of the hull. The top of the daggerboard case shall be parallel to the baseline with a tolerance of 2mm. To check this place the small square against the aft side of the slot and mark the case height. Repeat the same procedure at the forward side of the slot turning the square. The distance of the two marks shall not be more than 2mm **See photos at bottom.** No seals may be used except at the top of the slot.



Aft Trunk Measurement



Transom Measurements:

Draw one line across the transom between the sheer lines [see finding the sheer line] across the transom and another line across from the chine corner to chine corner.

Using the large transom sheer triangle place one edge against the lower edge of the measurement tool [base line] and slide the triangle forward until it contacts the transom at the sheer line. This location is the maximum length of the hull and shall be between 4711 and 4737mm. The large triangle has one sharp and one cut edge, to check the maximum and minimum length allowed.

Make a pencil mark on the frame at the maximum length of the hull. Now find the end of the keel and make another pencil mark on the frame, then measure the distance between the two pencil marks, this is the transom horizontal offset distance who shall be between 203 and 220mm.



Measure the chine depth by using the chine [smaller] triangle and follow the same procedure as for taking the transom sheer measurement. **See photo at right.**

The edges of the triangle are cut in a different way to show the maximum and minimum depth allowed. The drawn line should be between the two opposite corners. Measure the widths of the sheer, chine and keel at the transom using a tape measurer.



The sheer and chine depth at the transom can be measured by either the process used for the stations or simply measuring down to the drawn lines with a high quality rule.

Use the same rule to check the keel depth measuring down from the base line to the end of the keel, this shall be between 166 to 178mm.

Measure the distance from the top of the deck's height to the sheer, this shall be no more than 127mm.

To finalize the transom measurements it is smart to check that the rudder is hung at the proper depth by extending the keel to the Rudder Datum Point. It is quite a bit more difficult once the boat is back on her trolley. The keel extension shall cross the Rudder Datum Point with a tolerance of 6 mm above or below.

See photo in <Appendages>.

For boats built after 01 January 2001 the rudder gudgeons shall be mounted between 152 to 158 mm above the keel intersection for the lower gudgeon and from 407 to 413 mm for the upper gudgeon. The internal diameter of the gudgeons shall be between 8 to 8.5 mm.



Chine measurements

Chine depths [vertical measurements] are found sliding the cross member to each station and measuring down using a high quality ruler. Minimum and maximum at the stations are displayed on the Measurement Data Sheet.

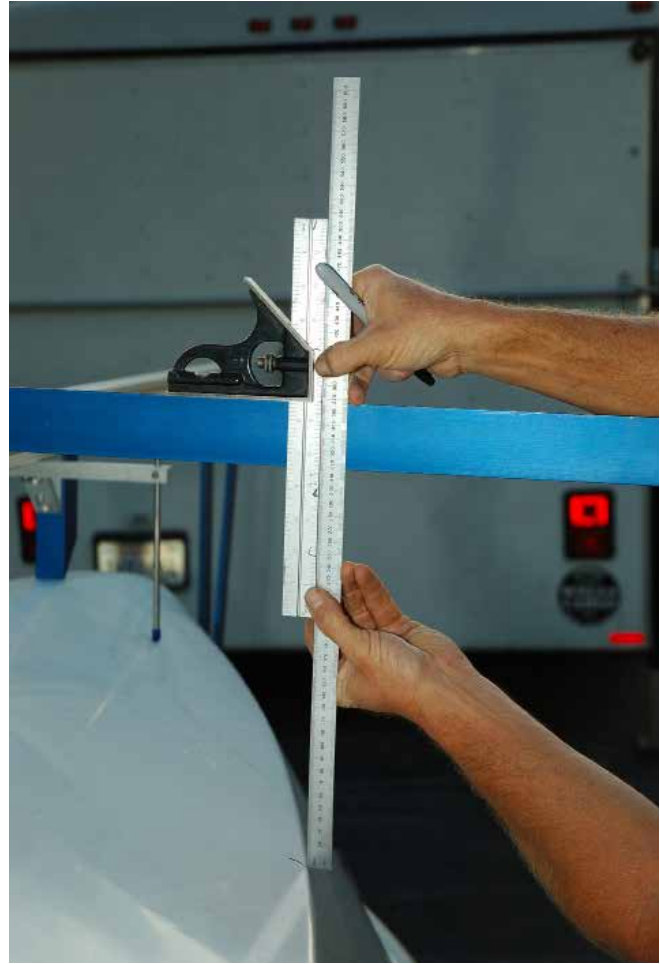

Chine widths [horizontal measurements] are found measuring with the large caliper the distance between the marks [see Station Measurements] at each station. The slider shall be between the correspondents marks on the large caliper. When certifying the mould it is smart to check the actual measurement between the two tips.

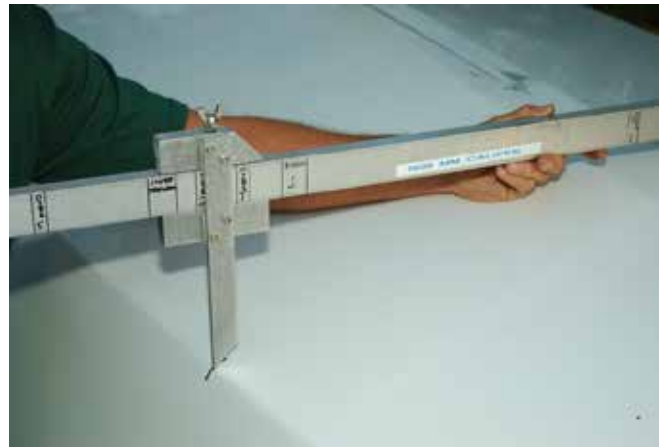

Hull transverse sections

The segments of any transverse section of the bottom and side panels from station 1 to 6 including the transom shall be straight with a maximum tolerance of 1%.

To perform this measurement you will need a very straight piece of bar. Simply place the bar in the field of the hull and measure the concavity (at the middle of the bar) or the convexity (at the extremities). The best way is to use a drill bit of the appropriate diameter. Check the total length of the section. The concavity or convexity (average of the two measurements above) shall be less than 1% of the length of the section. It is recommended that you take at least 6 measurements on each axis at various points on the hull. [See photos.](#)



The hull measurements are now complete and the boat is ready turn right side up. Before you do so check to be sure that you have the Hull Datum Point mark and the sheer line marks for each station on the deck.

Radius Measurements

Measure the established radiuses using the tool that is an arc of a circular sector. See Fig. 1. The one shown in the pictures is a sample. The tool should be made of aluminum or rigid plastic of at least 1mm of thickness to prevent any bending and with very sharp edges. This way the results of the measurements are very close to the same measurements made using CAD software.

The inner radius shall be the same of the radius to be checked (25mm for the bow, 19mm for the chine), the outer radius shall be enough to physically handle the tool.

The two tools shown in Fig. 1 have 25 and 19 millimeters respectively and have a different angle of the arc. We suggest an angle of 75° for the 25mm and 55° for the 19mm tool. A smaller angle should give more accurate measurements, but the reading will be more difficult.

To check the radius, simply draw on each side the beginning of the curve with a pencil, then place one edge of the tool on that mark and move it to the same mark on the other side of the curve. See Fig. 2



If the edges of the tool don't touch the surface, the radius is correct; if the edges of the tool touch the surface and there is space in the middle, the radius is greater than allowed; if the tool fits the curve the radius is the maximum allowed. See Fig. 3 to 7.

The same procedure, with adequate tools (with different inner radius) shall be used to check the remaining chine radiuses.

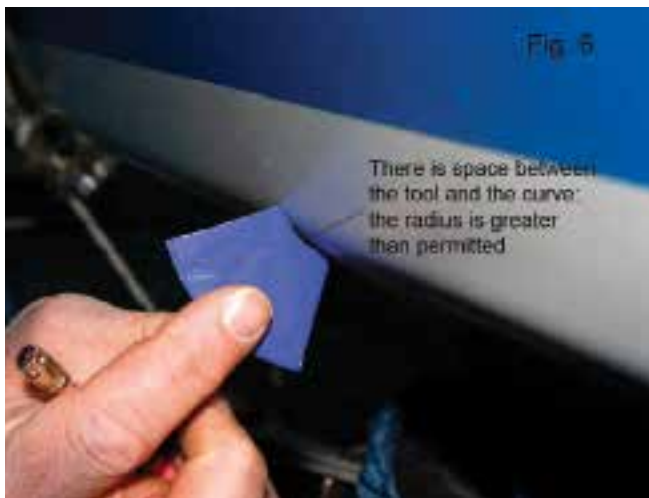
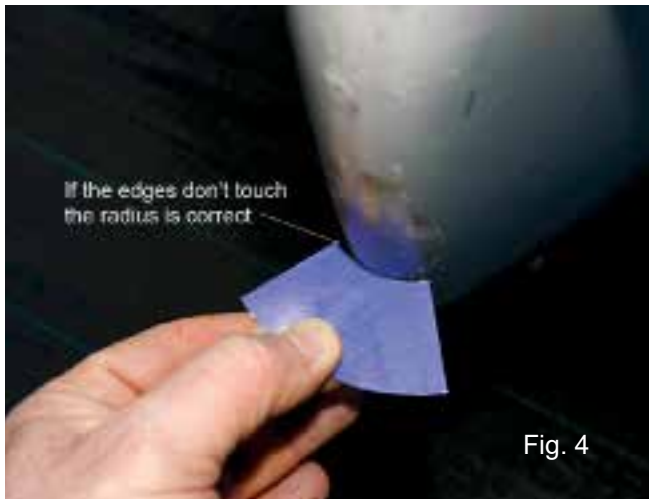

Deck Measurement

The deck measurements have many provisions for the huge amount of variations in the deck configuration; the basic measurements are detailed in the following manual and should be treated as the default measurements. When a different or challenging configuration presents itself refer to the Class Rules for clarification. If the boat is built after 2001 it is of great help to set it horizontal placing a level on the daggerboard case.

Deck Width Measurements

Start by measuring each of the sheer lines widths from station 1 thru station 5 using the large calipers. Refer to the Class Rules or Measurement Data Sheet for these values. [See photos.](#)



Now measure the width of the cockpit from the inside edge of the deck on the port side to the inside edge on the starboard side, this distance shall be no more than 1016mm. If the deck curves down with a radius, to find the measurement point place the large caliper on the sheer lines at the maximum width of the cockpit, measure down the distance from the top of the bar to the sheer line, add 51mm. The cockpit width shall be measured at this exact height.

The projection of the sheer strakes shall project no more than 32 mm horizontally from the sheer line.

The gunwale maximum radius shall be 12 mm.



Deck Length Measurements

All length measurements originate from the Hull Datum Point at the stem and are measured perpendicular to the center line of the boat. See photo at right.



Side stays

When the attachment point for the side stays is being measured the measurements shall be taken from the centerline of the holes for both minimum and maximum lengths. See photo.

Use a tape measurer to link both the forward and aft holes of the stay attachments, then use the large caliper to measure the distance from the Hull Datum Point to the tape measurer.



Headstay fitting:

Starting from the Hull Datum Point the forestay fitting shall be positioned with the fore hole between 279 and 330mm aft hull datum point, measured parallel to the base line and no more than 45mm above the sheer line. Max diameter of fore hole 6mm. To measure the height of the fitting, determine the sheer lines at both sides. Then, using a straight rod slipped in the hole, check the height from the centre of the hole to the sheer lines on both sides. The average shall be less than 45mm. See photo.



Splash boards:

Measure the length of the splash boards, including curvature, they shall extend 610 mm from the center line on both sides of the deck. Within this length, the splash board height shall be at a minimum 51mm from the foredeck to the top of the splashboard.

Mast spar hole:

The forward edge of the mast spar hole in the deck shall be no less than 1494 mm from the Hull Datum Point. The best method to take this measurement is to use the large calipers. [See photo.](#)

The maximum size of the opening is 76 mm wide and 254 mm long.

If less than 1494 mm, an adequate plate shall be placed at the front of the hole to reach the minimum.



Foredeck:

The foredeck must extend full width to a distance at least 1842 aft of the Hull Datum Point.

If the deck curves down with a radius, the actual length is taken at the intersection of the horizontal and vertical planes. [See Photo at right and at the top of next page](#)

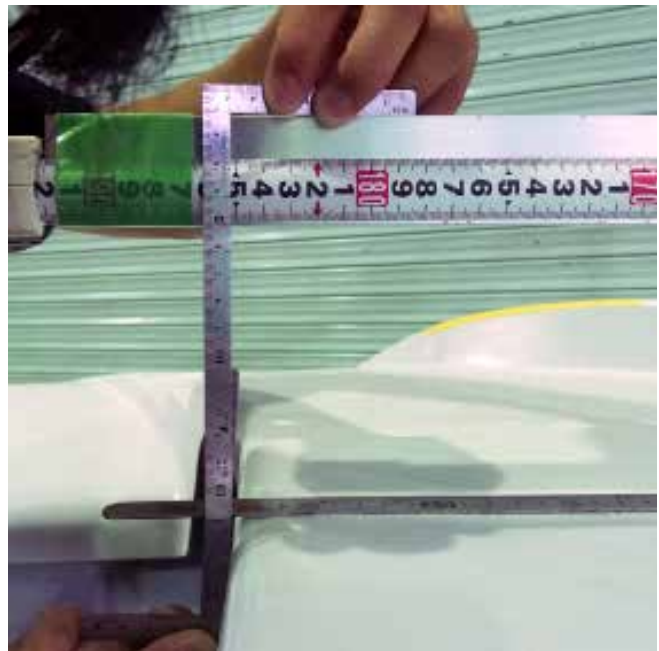

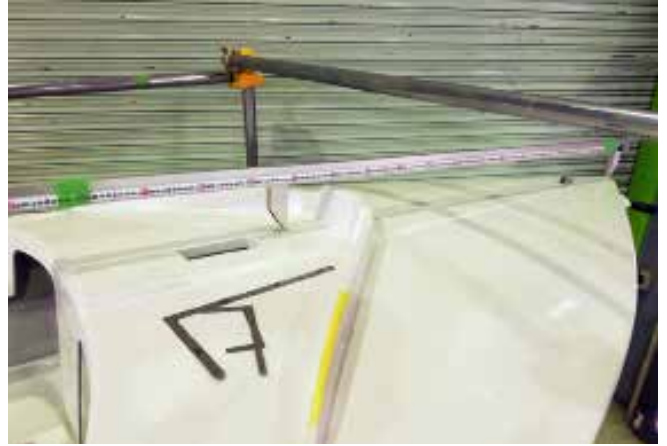
**Afterdeck:**

The afterdeck shall be no less than 457 mm forward of the actual transom [not sheer] [See photo](#).

**Deck Thickness:**

The deck may be plywood or Glass Reinforced Plastic or a combination of the two. Check the Class Rules for the applicable prescription.

Mast step

Verify that the mast is stepped using only one transverse pin and the fore and aft movement is no more than 2mm in any direction. Any mast step is allowed, including those with a slider to adjust the mast position, providing that the slider is fixed with a bolt and nut or screw.

The mast step shall be 390-400mm from the sheer. To perform this measurement use the large caliper placing it at about 1575 mm aft the HDP, measure down the distance to the mast step fitting, then subtract the distance from the caliper to the sheer. [See photo](#)



Moment of Inertia

Hulls with any optional and mandatory equipment and including hiking straps, any controls, mainsheet and compass if fixed on the hull, but excluding the jib sheet, shall be subject to the moment of inertia test (see Class Rules, Part III.H3). All hiking straps, sheets and control lines shall be in dry condition; the mainsheet shall be deployed as close as possible to the CG on the cockpit floor.

The moment of inertia of the hull is calculated from the following formula:

$$I = \frac{CD^2T^2}{4\pi^2}$$

Where: I = Moment of Inertia
 C = Spring constant, kg/sec².
 D = Distance to axis, m.
 T = Time of one complete oscillation, seconds
 $\pi = 3.1416$

For our purpose, D = 2.6233 m.

The spring constant will be furnished with springs from SCIRA.

The maximum weight of the attachment shall be 350gr excluding the springs only; if desired, corrector weights shall be added to the aftermost part of the attachment to reach the maximum weight.

We can now simplify the formula to:

$$I = \frac{(2.6233m)^2CT^2}{4 \times 3.1416^2} = (0.1743m^2)CT^2$$

The minimum moment of inertia of the hull as determined from above formula shall be: 271 Kg*m²

If the hull moment of inertia does not meet the minimum, weight shall be moved to or added to the ends to bring it up to the minimum.

Set the moment of inertia jig up on a hard level surface and check to see that it is reasonably level both lengthways and sideways. Also check the 2642mm dimension from the aft side of the riser to the front side of the 19mm dia. balance rod.

Carefully balance the hull by moving it back and forth on the balance rod so that the top of the deck is level with the horizontal line on the riser. Be sure to use a thin metal plate (152x152x3mm is recommended) between the balance rod and the keel. Also the spring attachment assembly minus springs should be in position on the fore deck. When the hull is balanced, attach the springs to the spring attachment assembly and then to the hooks on the riser, being careful to stabilize the hull while doing this operation. Adjust the spring attachment assembly so that the centreline of the spring bolt is 25mm from the aft side of the riser and clamp the assembly to the deck with the hook bolt through one of the holes in the



forestay fitting. Recheck to see that the Hull Datum Point is level with the horizontal line within plus or minus 6mm and adjust the hull position if necessary.

The hull should now be free to oscillate about the pivot rod, being restrained only by the springs. Check this by displacing the bow approximately 76mm to 102mm above or below the horizontal and allowing it to oscillate. Please notice that an oscillation is one complete cycle, from starting point to farthest away point and back to starting point.

Proceed to time the hull oscillations through a minimum of 20 complete oscillations. Divide the total time by the number of oscillations to arrive at the average time for one complete oscillation. Repeat is procedure twice to check that the average oscillation time is correct to the nearest thousandth of a second, starting with 76mm to 102mm bow displacement each time. Please note that the stopwatch is started at the beginning of the first oscillation but the number count is started at the end of the first oscillation.

Using the average time for one complete oscillation, solve the formula for moment of inertia.

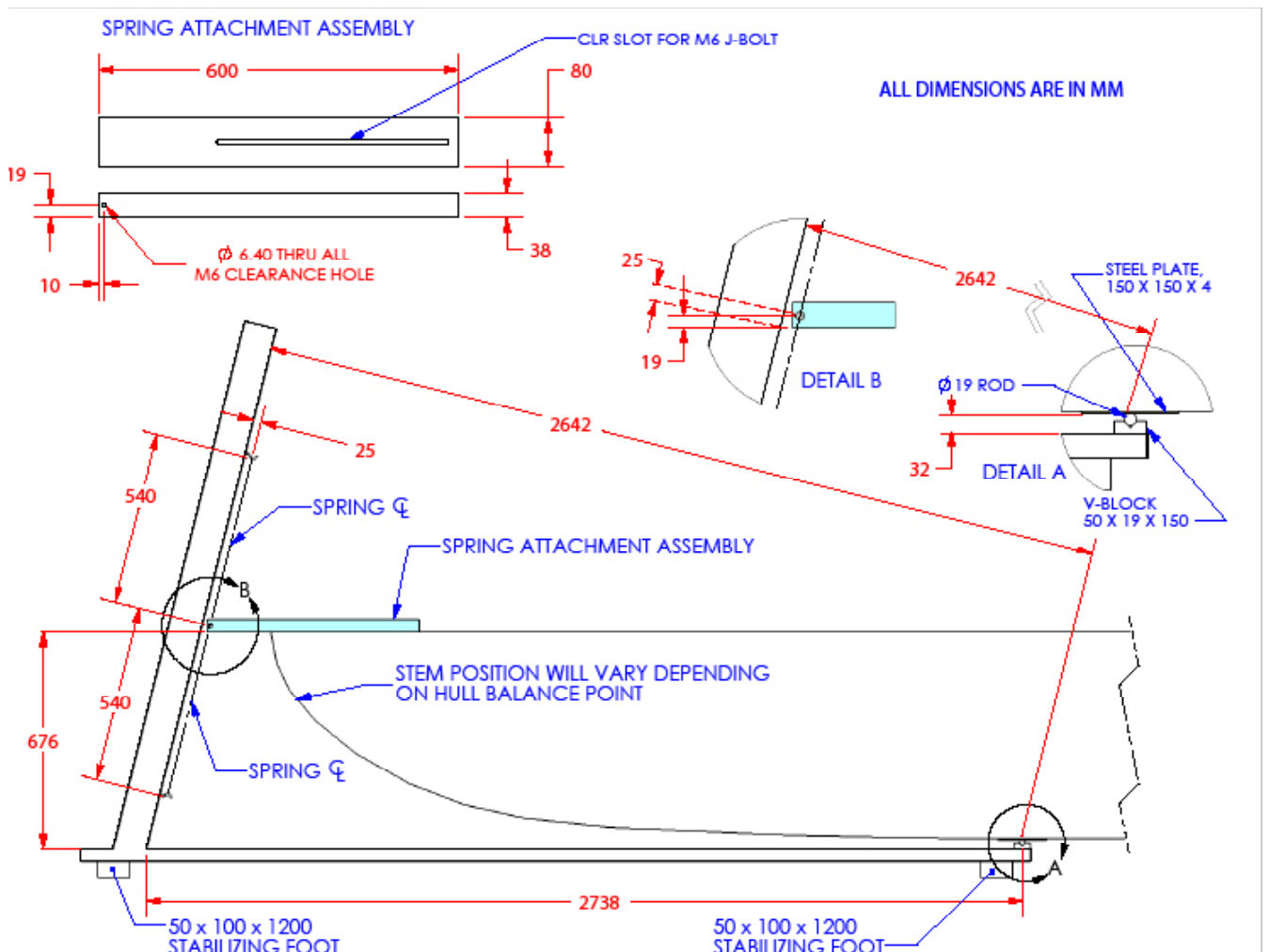

Rig

Mast Measurements:

It is best to measure the mast on the tops of two long tables, separated enough so that the mast will lay flat on the table with the spreader bracket laying between the tables.

There are different mast measuring rules that apply; boats that were built prior to 2001 and those built after 1st January 2001.

Pre 2001 boats: Locate and mark the sheer lines on each side of the hull about 1575mm aft of the Hull Datum Point using the sheer locator tool. Next using the large caliper to mark the sheer point on the mast.

NOTE: the mark you make on the mast should be on the top of the caliper crossbar. Remove the mast from the boat and place it on the tables. Next measure down from the mark the height of the caliper from the top to the side measuring points. Mark that point. This is the Mast Datum Point.

Post 2000 boats: place the mast on the table and take the measurements. The total length of the mast from the heel point to the upper point shall be 6499mm at maximum. Mark the virtual Mast Datum Point measuring down from the upper point 6109mm. Please remember that this is NOT the actual MDP to be used for pre2001 boats.

Measure the mast according to Class Rules F3 and additional limitations; be sure to check overall length, limiting marks location and dimension, spar section and dimensions, shroud, stay and halyard intersections, stopper and gooseneck section if required.

Weigh the mast by finding its balance point; refer to Class Rule F.3.4 for its center of gravity. A maximum of 100gr of corrector weights might be added to reach the minimum weight, providing that the spar complies to the CoG rule. The spar is weighed with halyards shrouds and spreaders attached in normal position, fixed with tape at the Mast Datum Point.

Boom Measurement:

Lay out the boom on the tables and slide it onto the gooseneck. All the measurement are taken from the aft edge of the sail slot. If the slot is cut, from its extension. Using the small triangle square the boom to the mast then check the length of the gooseneck. This measurement shall be max 42mm. [See photo at right](#) Then measure to the front of the outer limiting mark and then the overall length.

Other measurements to check for are the outer mark limit pin, limiting mark dimension and boom section dimensions. [See photo at bottom.](#)

Don't forget to check the boom cut offs at extremities (max 45°) and the sail slot cuts away (max 350mm). See Rule F4.2.

Whisker Pole

This is also the best time to measure the whisker pole and pole launcher system. The maximum length shall 2642 mm. Note that this measurement is only an overall measurement. Also verify that the pole block isn't projected beyond the front of the mast.



Appendages

The use of Mylar templates will greatly simplify measuring the appendages. Having a large table for measurement will make the job more comfortable.

Rudder:

The rudder can be tricky to measure, make sure that the Rudder Datum Point and the front edge are properly aligned over the template. Measure the shape and thickness above and below the water line. Note it is important that the rudder be positioned with the Rudder Datum Point in the correct place as this serves as the basis for the shape measurements. The blade shape shall be between the maximum and the minimum allowed. Hang the rudder on the gudgeons while the boat is up side down for its hull measurements and check that the rudder is parallel to the transom – with a max tolerance of 2mm - and that the Rudder Datum Point is positioned correctly within the tolerances of the rule (+/- 6mm)

Other items that will need to be checked are:

- weight of the rudder and corrector weights,
- retainer pin for both the tiller and the rudder and
- check of the pintles diameter.

Refer to Class Rules C8.5 and E3.3 for allowed tolerances and specific restrictions on rudder shape.

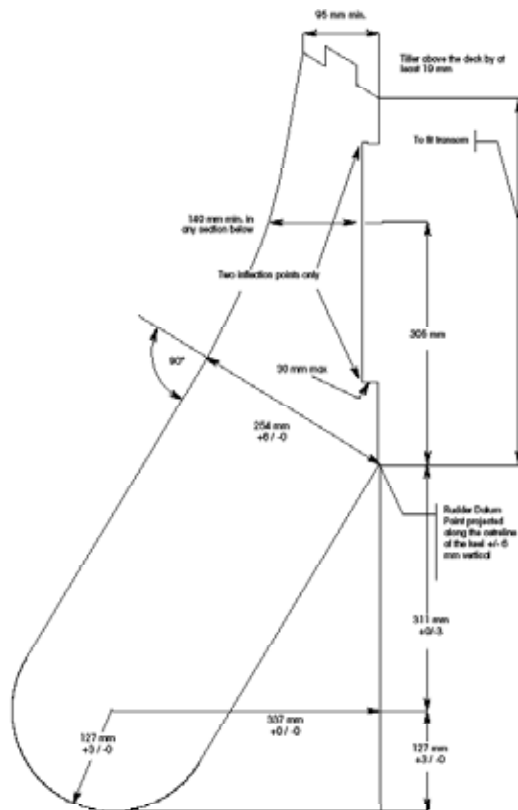

Daggerboard:

Lay the daggerboard over the template and check the dimensions, tapering and punch mark. Note; to accurately check the taper use a combination square with the straight edge on the surface of the blade and the frame portion resting against the edge. 25mm is allowed by the rules. Measure up from the bottom of the blade 851mm and permanently mark the blade with center punch. Check that the dagger board does not protrude below the keel any further than the punch mark. The easiest way to check this is to measure the depth of the slot at the aft part of the case and from the punch mark to the stoppers on the blade. They should be equal. For boats built after 2000 the measurement shall 310 - 313 mm.

Ensure that the dagger board hangs perpendicular the baseline (note this is not the keel line) using the measurement taken when the boat was upside down. Measure the slot width and length.

Verify that the retainer to set the dagger board height is either a tablet or a hook with cutouts on the daggerboard. To check on the water the compliance of the board maximum retracted position, a contrasting stripe 25mm high and 350mm long shall be painted on each side of the blade from the leading edge. The top of this band shall be even with the topmost surface of the deck when the board is completely retracted (at max height). To draw the stripe, check the daggerboard slot height at the aftermost part of the case and the height of the top of the deck at the boat centerline from the top of the forward part of the daggerboard case. Sum the two measurements with 305 (max board position up) to get the position of the upper part of the stripe.

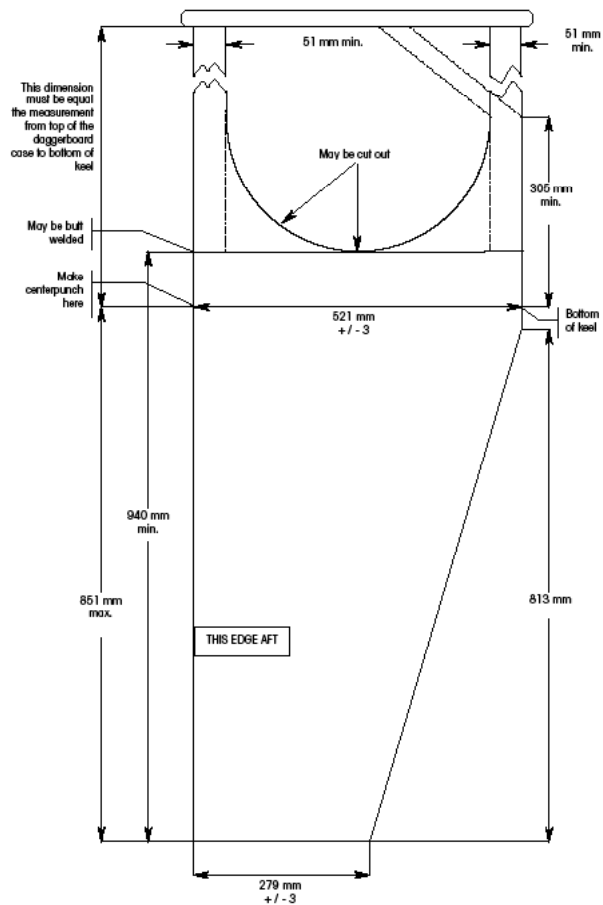

Verify that there is a suitable safety line so that the daggerboard may be raised only to its legal limit while racing and strong enough to secure the board when the boat is capsized. The line shall be directly fixed to the daggerboard case and connected to the blade with a metal shackle or carabiner. The length of the safety line shall be 610mm from the top of the daggerboard case to the inner part of the shackle. It shall be a single piece and shall not be adjustable.

The hole on the daggerboard shall be above the lower part of the stopper [See photos](#).



Safety Equipment

Check that the Snipe being measured has a useable paddle and a 15 meter x 8mm floating single piece tow line. Each Snipe must also carry two personal flotation devices to the minimum standard ISO 12402-5 (Level 50 Newtons), or USCG Type III, or AUS PFD 1, or EN 393, unless an equivalent standard is prescribed otherwise in the Notice of Race.

Carbon or aramid fibres

Carbon or aramid fibres can be used in fittings and their supports, running rigging (see Rule F.7), tiller extension (see Rule C.8.5.a.6), splashboard (if not moulded with the boat, see Rule D.1.5) and in the compass support (see Rule C.5) only.

Ropes can contain carbon or aramid fibres. Halyards cannot be made out of carbon or PBO (see Rule F.7). See the above mentioned Class Rules and the World Sailing Equipment Rules of Sailing for additional details.

Sail Measurement

Measuring the sails is fairly simple and follows the World Sailing prescription for sail measurement. The tools you will need are a 8m tape measure, a high quality ruler and a set of jib head, tack and clew templates. You may also need a paper tape to properly locate the head, clew and tack point on both sails.

Main sail

Start by laying out the main on a very large table or on a floor.

First measure the leech dimension from the head point to the clew point. Tension the sail to remove wrinkles. Record the measurement. Now remove the battens as the next measurements will be much easier to make once the battens are removed.

Fold the sail in half laying the head point over the clew point. Remove all of the wrinkles by gently stretching the sail so that a clear crease at the half way point, mark the point with a pencil. This is the middle width measurement point.

Move the head to the half width mark and place the head point on the pencil mark. Remove wrinkles and straighten the leech and make a mark at the half way point, this will be the upper quarter width measurement point.

Move the clew to the half width mark and place the clew point on the pencil mark. Remove wrinkles and straighten the leech and make a mark at the half way point. This mark is the lower quarter width measurement point.

Replace the battens.

The sail is now ready to measure the widths. Take a tape measurer and measure across the widths by leaving the end of the tape at the mark on the leech and laying the tape across the sail to the nearest point on the luff including the boltrope (roughly perpendicular to the luff). Swing a short arc to be sure that at the shortest point the dimension is not greater than allowed.

Repeat this for the upper, middle and lower quarter widths.

Now measure the batten pockets, the center of the pocket at the leech shall be no more than

| | |
|---------------|---|
| Top batten | +/- 36 mm from the three quarter width position |
| Center batten | +/- 46 mm from the center width position |
| Lower batten | +/- 60 mm from the quarter width position |

The center of a batten pocket shall be defined as the free space between the inside part of the stitching lines in the pocket.

Measure the three battens with a tape measurer and record those measurements.

Measure the dimension at the top of the sail, the top width including the boltrope shall be no more than 185mm. Also check that the top of the sail is no more than 90° from the luff.

Verify that the boltrope at the tack is cut off no further than 254mm from the tack corner. The boltrope at the head and the clew shall be cut off perpendicular and even to the ends of the sail.

The minimum weight of the cloth or laminate allowed for mainsails is 130 gr/sqm.

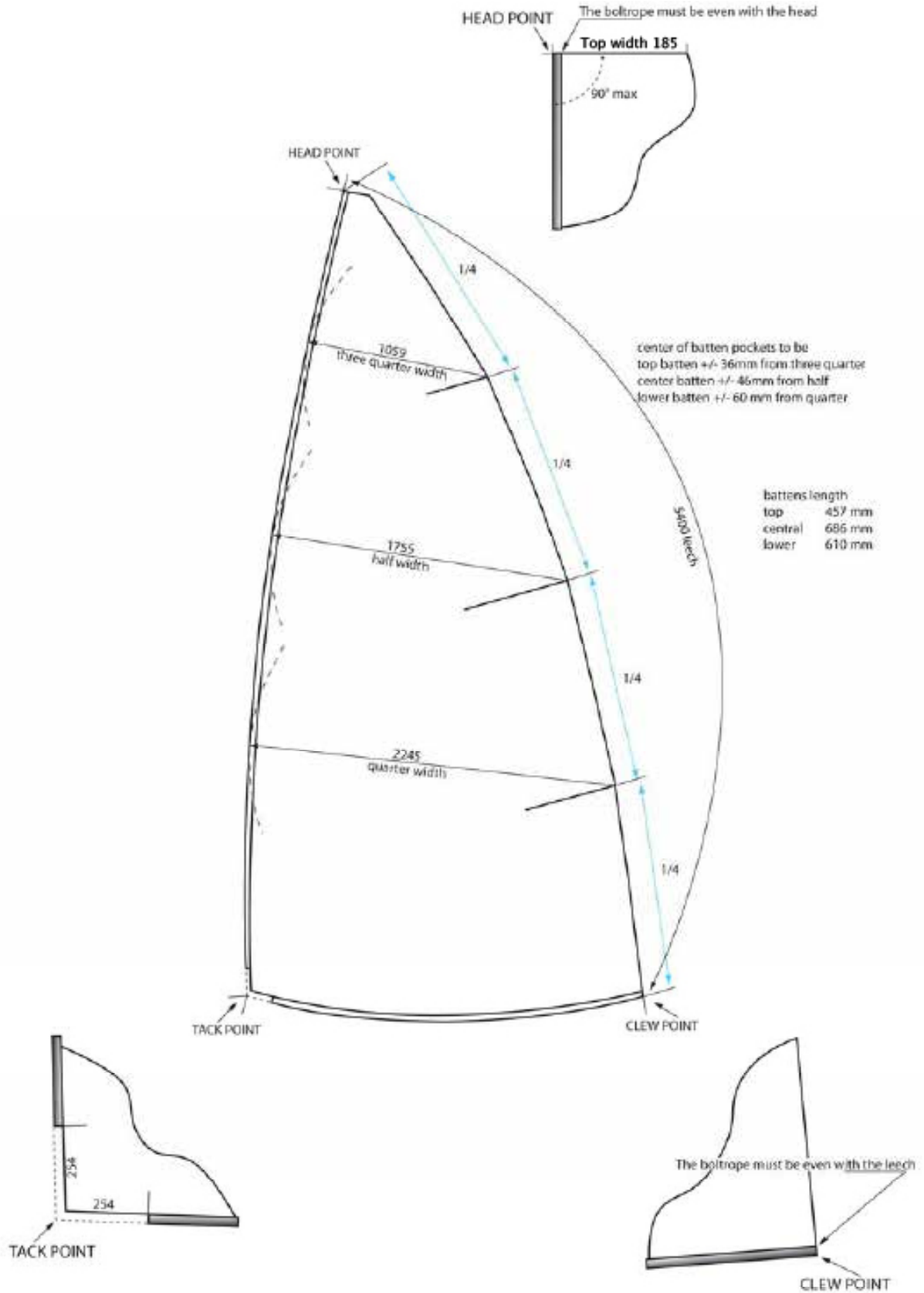

Jib

The jib perimeter is measured as well as the head, the mid foot to head and the middle width.

Start by folding the jib in half from tack to clew so that the tack point and the clew point match, using a pencil make a mark at the crease at mid foot, remember to straighten away any wrinkles that may affect the measurement.

Lay out the jib on a flat surface and remove as many of the wrinkles as possible.

Using a tape measure from the head point, measure down the luff then the mid foot and lastly the leech. Remember that you are measuring from the head point to respectively the tack, mid and clew points.

Now measure the foot of the jib from the tack point to the clew point and record all these measurements.

Then measure the mid width by folding the jib so that the head point matches the clew point. Mark this point with a pencil. Take a tape measurer and measure across the mid widths by leaving the end of the tape at the mark on the leech and laying the tape across the sail to the nearest point on the luff (roughly perpendicular to the luff). Swing a short arc to be sure that at the shortest point the dimension is not greater than 1025mm.

The last measurement is the head of the jib, this area of the sail is always built very close to the maximum dimensions. From the head point measure down 155mm along the luff and the leech marking each with a pencil. Now measure the distance between these two marks. The maximum dimension is 115mm. Check that the top of the jib is no more than 30mm and is max 90° from the luff. The jib is now measured.

The minimum weight of the jib cloth or laminate is 160 gr/sqm

APPROVED MAILAR LAMINATES AS FROM JANUARY 1ST 2013

For both sails Bainbridge SL 1000P
 Diax 60 P

For main only Dimension Polyant PM-05 (1.5 mil), formerly M 290

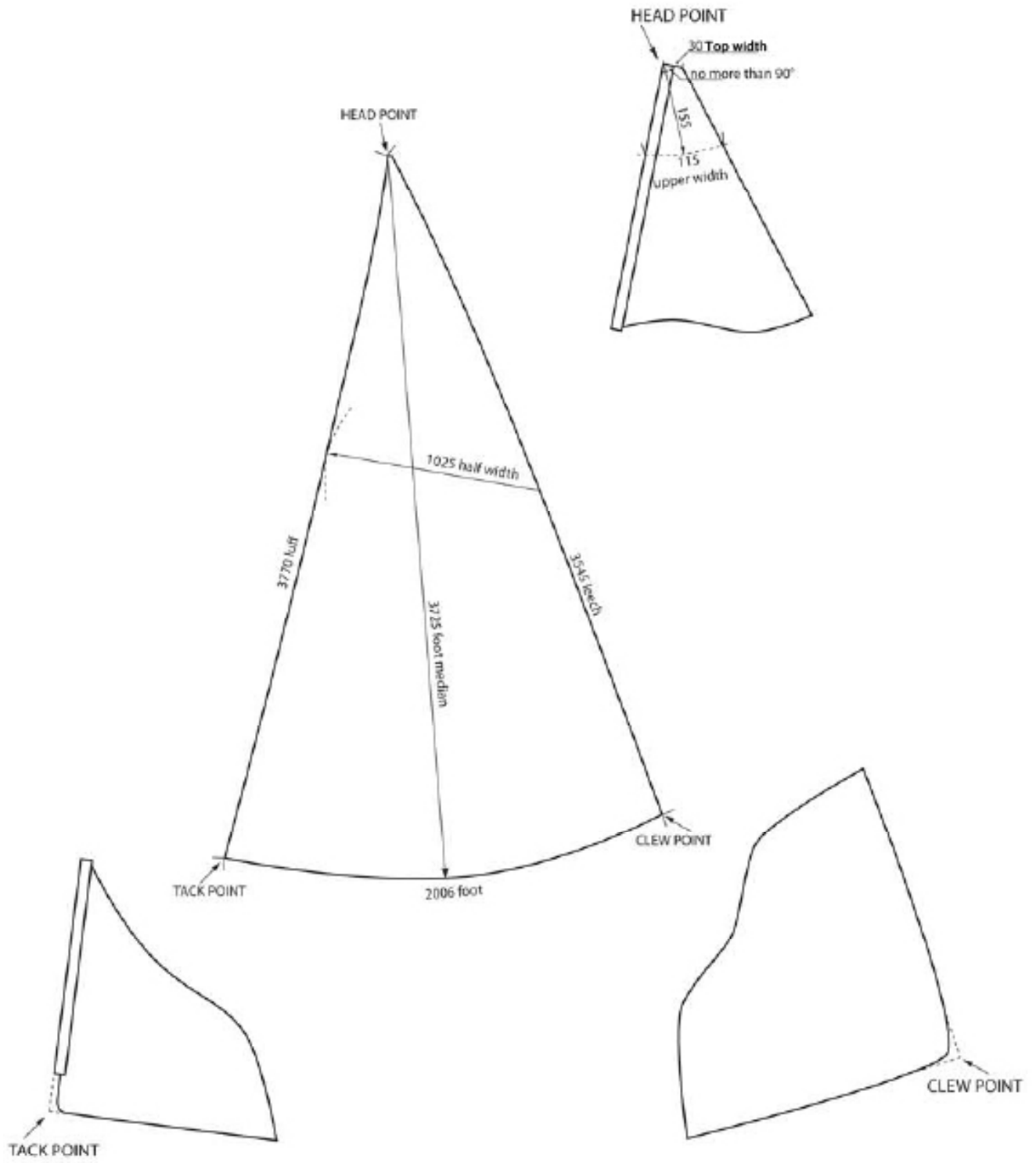

Weighing

Boat

Tools needed

- A scale of 200kg minimum load, either conventional or electronic. In a championship the scale should be checked before the weighing session.
- Hanging system, whose weight shall be set as tare on an electronic scale or subtracted from the total weight on a conventional scale.

The boat shall be presented in dry conditions (no water inside, no wet sheets...) with the following equipment:

- Hull fittings and equipment
- mast, complete with rig and fittings
- boom and whiskerpole
- main and jib sheets
- rudder
- tiller and extension
- compass

The following equipment shall not be included:

- Safety equipment (Paddle, Towing Line, 2 Buoyancy aids complying with the Class Rules)
- Personal tools or equipment

The minimum weight in the above conditions shall be 172.8 kg

If not the minimum, corrector weights shall be added in any position to meet the minimum MOI. The corrector weights shall be visible. If inside the side tanks, they shall be visible through the inspection ports. If a boat already has a Measurement Certificate, there is no need to check the MOI again.

If the weight is above the minimum, corrector weights can be taken away, but the MOI shall be checked again.

During a championship or a regatta no change in the amount of the corrector weights is allowed.

The amount and position of every corrector weight shall be marked on the Measurement Certificate.

Mast

Tools needed

- Any suitable scale with 20 kg minimum load (a luggage scale or a person weighed are recommended).
- Any suitable system to support the mast (a latch or a triangular prism for example)

Shrouds, shrouds adjusters, spreaders and forestay shall be in place, the rig shall be fixed at the Mast Datum Point using tape. The exceeding rig shall be left free.

Halyards shall be inside the mast. The exceeding shall be left free to touch the ground

The whiskerpole pulley and the related equipment is included in the mast weight. The compass, its support, the wind indicator and any other fitting are not included in the mast weight.

The mast is placed balanced or hanged on the scale. The balancing point shall be above the minimum CG distance from the Top Limiting Band allowed (3588mm).

If the mast doesn't reach the minimum weight 9.1 kg), corrector weights up to 100 g must be placed anywhere to comply with the CG requirement.

The amount and position of the mast corrector weight shall be marked on the Measurement Certificate.

Rudder

Tools needed

- Any suitable scale with 10 kg minimum load

The minimum weight shall be 2,72 kg.

If the rudder doesn't reach the minimum, corrector weights shall be added according to the following scheme:

- for rudders built until December 31, 2014 max 450 gr
- for rudders built from January 1, 2015 max 250 gr





Snipe Class International Racing Association

